



US00D610684S

(12) **United States Design Patent**
Gaydos

(10) **Patent No.:** **US D610,684 S**

(45) **Date of Patent:** **** Feb. 23, 2010**

(54) **MEDICAL CLAMP**

(75) Inventor: **Peter A. Gaydos**, Hilliard, OH (US)

(73) Assignee: **PercuVision LLC**, Gahanna, OH (US)

(**) Term: **14 Years**

(21) Appl. No.: **29/334,739**

(22) Filed: **Mar. 31, 2009**

(51) **LOC (9) Cl.** **24-02**

(52) **U.S. Cl.** **D24/143**

(58) **Field of Classification Search** D24/143,
D24/133, 128; D8/390, 395; 128/DIG. 25,
128/885, 325, 346, 320, 326, 227; 606/157;
24/499, 562, 557, 536, 508

See application file for complete search history.

(56) **References Cited**

U.S. PATENT DOCUMENTS

450,266	A	4/1891	Truax	
1,545,693	A	7/1925	Phoel	
2,010,074	A	8/1935	Fuerst	
2,634,728	A	4/1953	Dale	
3,786,816	A *	1/1974	Wolvek	606/142
D255,715	S *	7/1980	Markham	D24/143
4,227,730	A *	10/1980	Alexander et al.	294/99.2
4,314,724	A	2/1982	Barna	
4,360,023	A	11/1982	Sugita et al.	
D268,523	S *	4/1983	Scanlan et al.	D24/143
D276,461	S *	11/1984	Scanlan et al.	D24/143
D283,918	S *	5/1986	Jacobson	D24/143
5,007,827	A	4/1991	DiFranco	
5,053,045	A	10/1991	Schmidt et al.	
5,584,427	A	12/1996	Suaso	
D417,837	S *	12/1999	Nakamura	D8/395
6,056,342	A	5/2000	Chan	

D447,564	S *	9/2001	Stewart, Jr.	D24/143
6,352,293	B1	3/2002	Baschenis	
6,464,710	B1	10/2002	Foster	
D518,687	S *	4/2006	Baker et al.	D7/686
7,234,677	B2 *	6/2007	Zerfas	251/10
2009/0042662	A1	2/2009	Staszak	

* cited by examiner

Primary Examiner—Charles A Rademaker

Assistant Examiner—Charles D Hanson

(74) *Attorney, Agent, or Firm*—Gallagher & Dawsey Co.,
LPA; Michael Gallagher; David Dawsey

(57) **CLAIM**

I claim the ornamental design for a medical clamp, as shown and described.

DESCRIPTION

FIG. 1 is an left isometric view of a medical clamp showing my new design;

FIG. 2 is a right isometric view thereof;

FIG. 3 is a top plan view thereof;

FIG. 4 is a bottom plan view thereof;

FIG. 5 is a front elevation view thereof;

FIG. 6 is a rear elevation view thereof;

FIG. 7 is a right side elevation view thereof;

FIG. 8 is a left side elevation view thereof;

FIG. 9 is a right side elevation view in the set position thereof; and,

FIG. 10 is a left side elevation view in the set position thereof.

The broken lines are for illustrative purposes only and form no part of the claimed design.

1 Claim, 5 Drawing Sheets

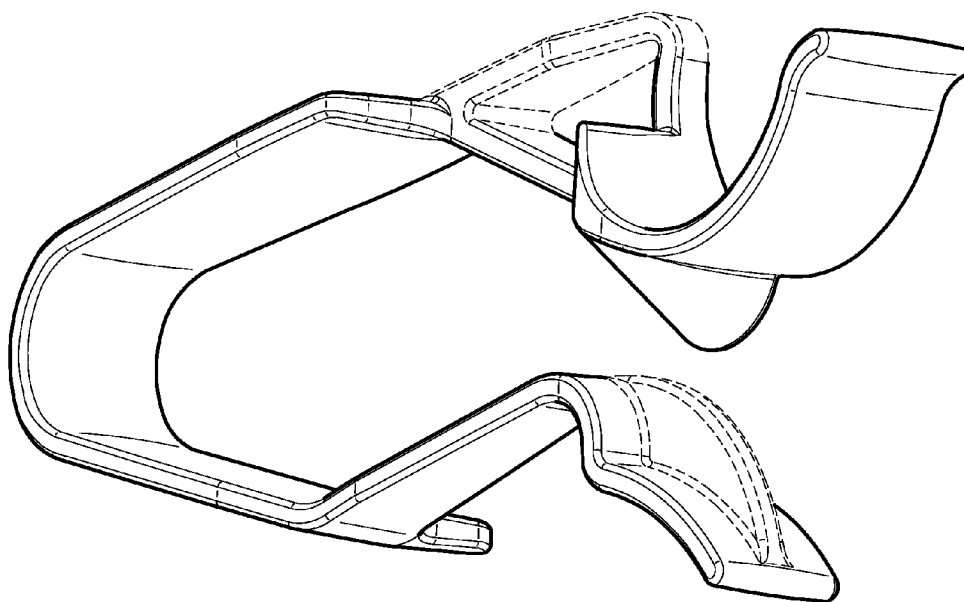

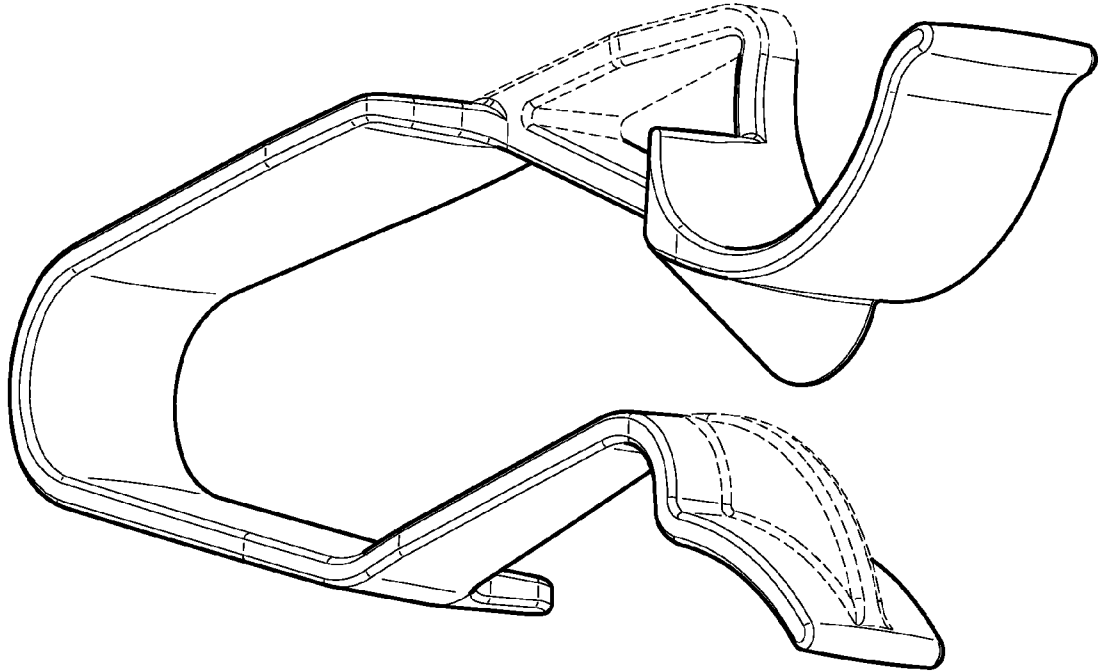

Fig. 1

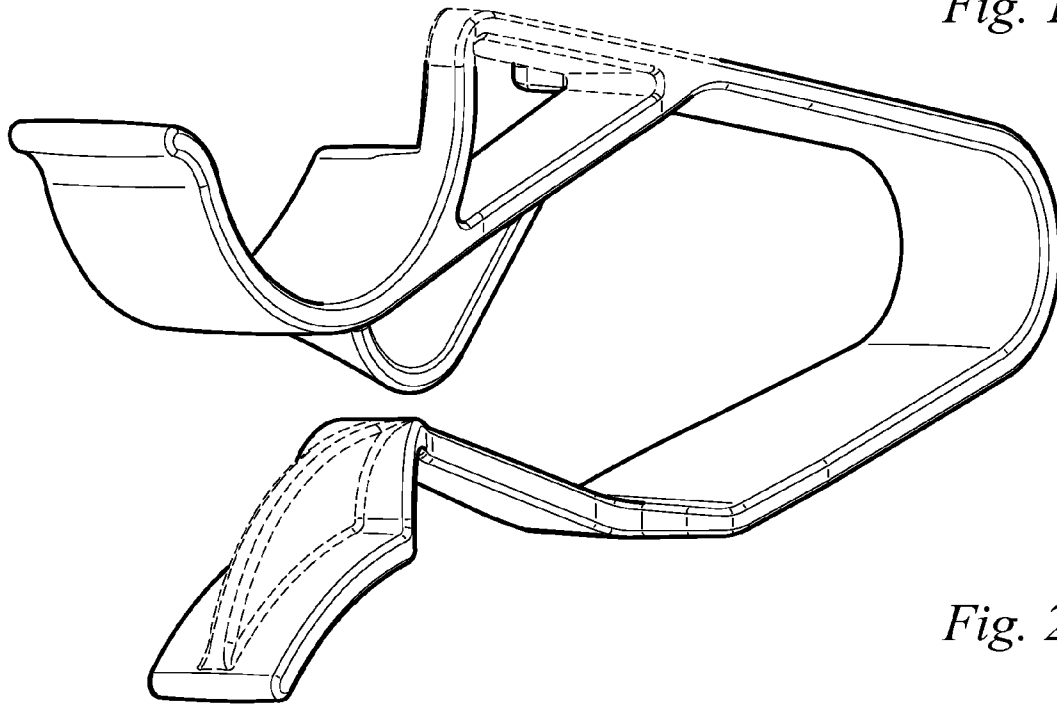

Fig. 2

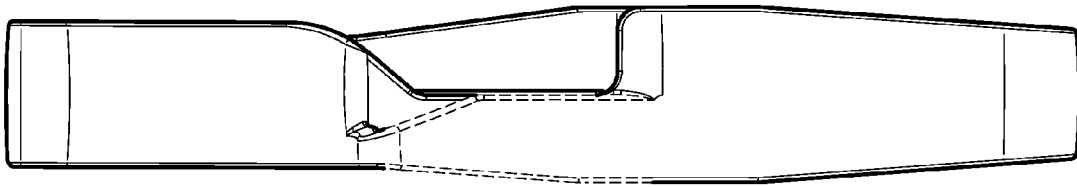

Fig. 3

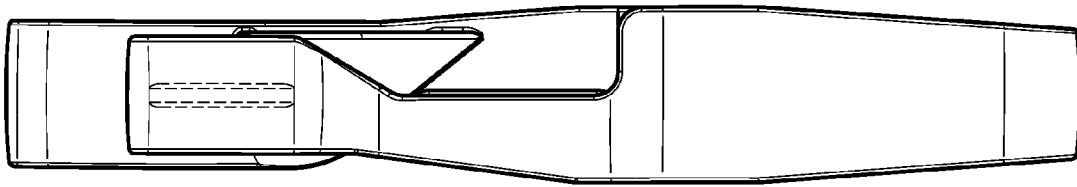

Fig. 4

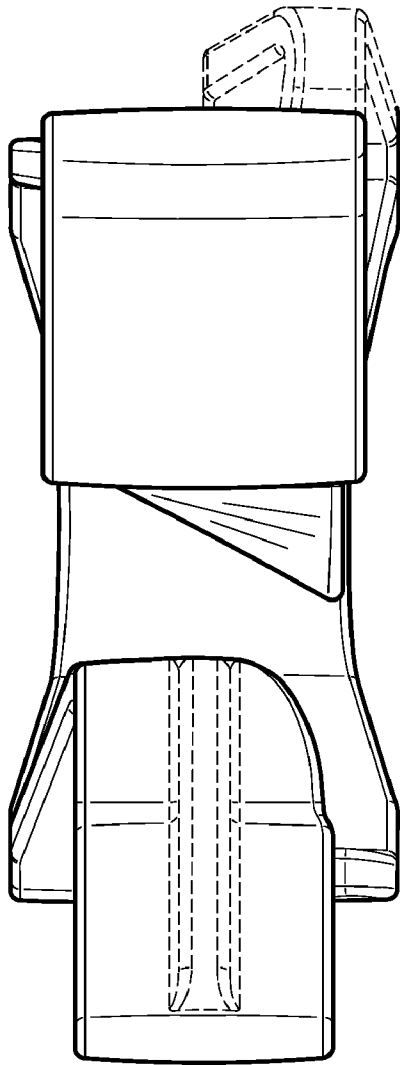

Fig. 5

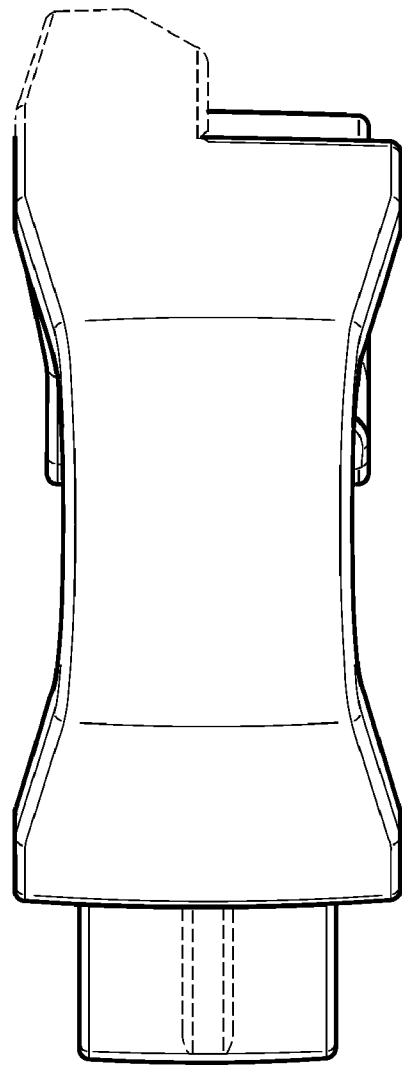

Fig. 6

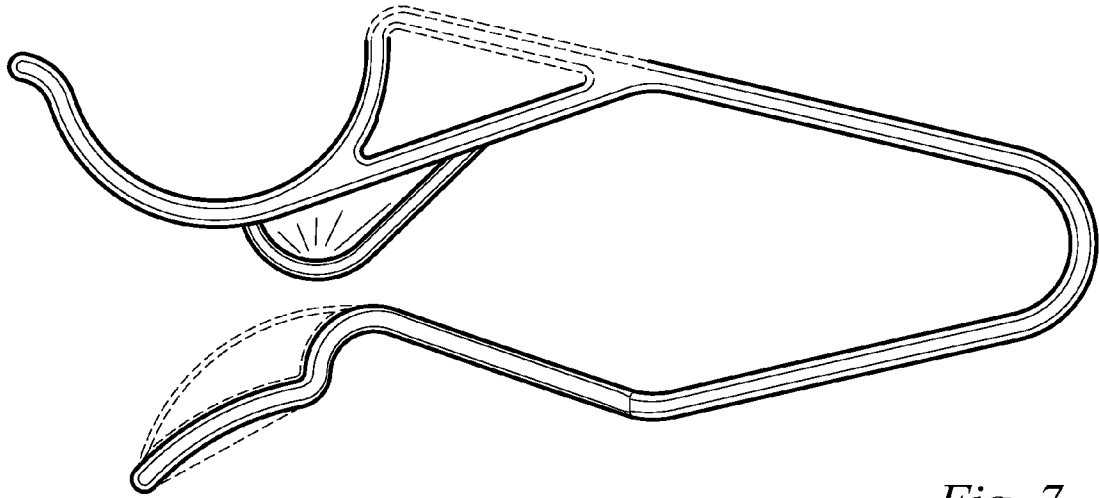

Fig. 7

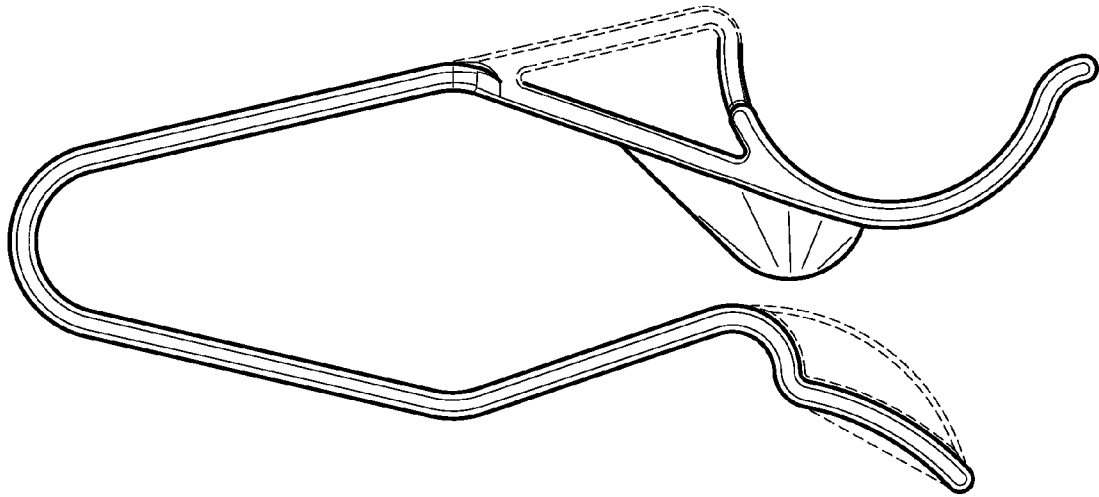

Fig. 8

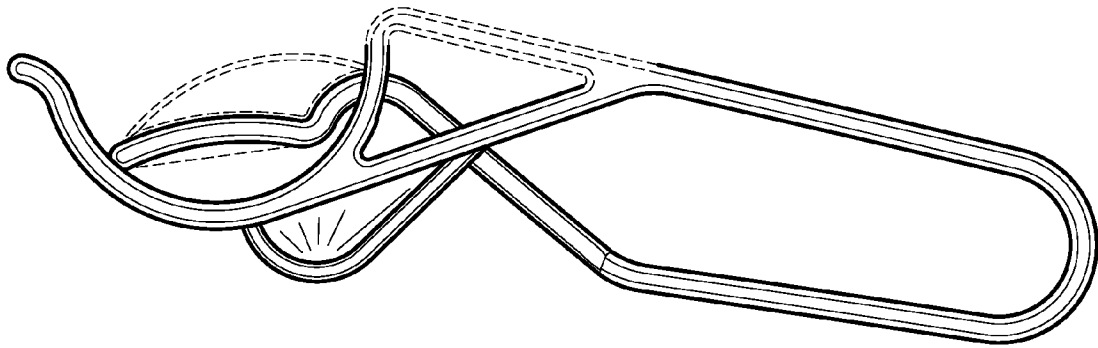

Fig. 9

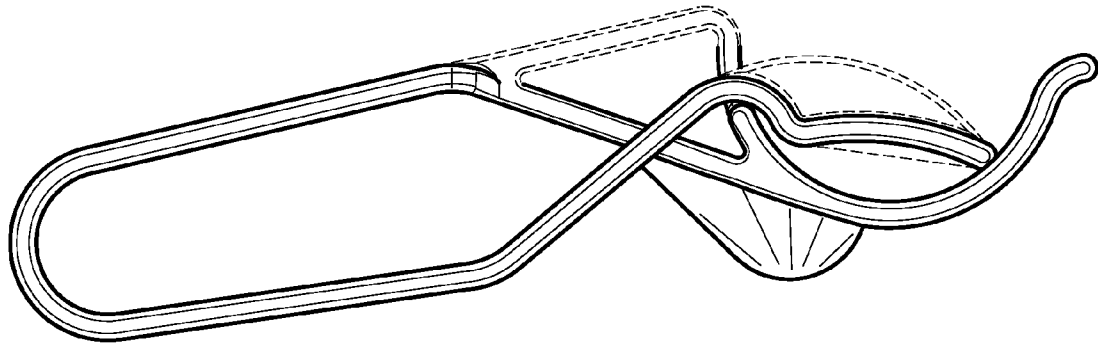

Fig. 10